



Autocollimators

6B-LED / 6D-LED



Autocollimators 6B-LED / 6D-LED

An easy-to-use, precise metrology instrument for angularity, parallelism, perpendicularity, straightness of precision components, machine guide-way and many other applications.

Nikon Autocollimator 6B-LED and 6D-LED both employ 70 mm aperture lenses to produce clear reflected images. They also feature extremely accurate double line reticles for improved detection. Both give readings of angular displacement to 0.5 seconds of arc using an easy-to-read large-diameter micrometer drum.

Features

- Efficient measurement because the autocollimator needs only the setting of a target mirror and collects reflected light rays.
- Vertical and horizontal axis values can be measured simultaneously.



Specifications

Telescope magnification	38 x
Objective	f= 700 mm; effective aperture: 70 mm
Measuring range	30 minutes of arc (both vertical and horizontal axes)
Minimum reading	0.5 seconds of arc
Readout system	Adjustment in viewfield and reading on micrometer
Measuring accuracy	0.5 seconds of arc within a range of 5 minutes of arc 1 second of arc within a range of 30 minutes of arc
Viewfield	6B-LED: brightfield, 6D-LED: darkfield
Light source	LED
Power supply	12V 5A (AC adapter is required) or size AA battery x2
Dimensions of main body	Outer diameter of lens barrel support: 68 mm Overall length: Approx. 490 mm
Weight (including stand)	Approx. 32 kg

Dimensions

Unit: mm

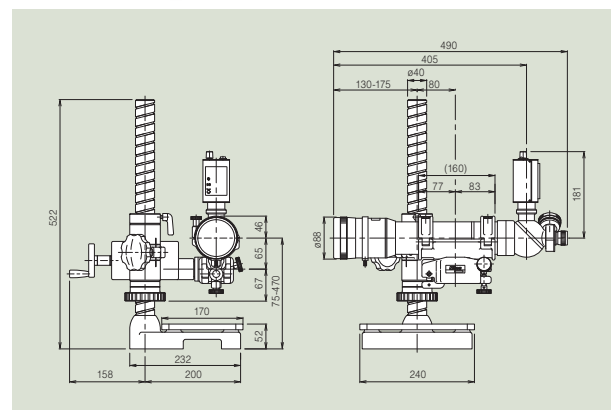

Viewfield diagram (6B-LED)

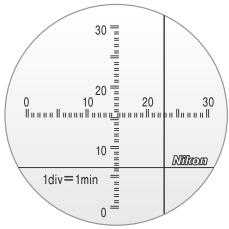

Viewfield diagram (6D-LED)

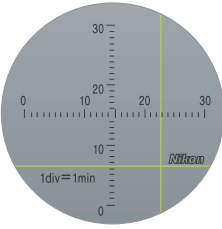

Bright & dark viewfield

The Autocollimator 6B-LED is a bright viewfield instrument in which a black crosshair image is visible on a bright viewfield, while the Autocollimator 6D-LED is a dark viewfield instrument in which a bright crosshair image is visible on a dark viewfield. Autocollimator 6D-LED is very effective when measuring with a small plane mirror or a low-reflective plane surface.



LED illuminator

Both can operate on two AA batteries, enabling the instruments used in the environment where AC power is not available.
*No battery charging capability



Measurement of radius of curvature for convex and concave surfaces

The light rays can be made to diverge or converge by turning the objective correction ring. This function allows measurement of the radius of curvature for convex and concave surfaces.



Case for Autocollimator

Aluminum storage case for Autocollimator 6D/6B and 6D-LED/6B-LED.



Plane Mirror B

Large extremely accurate reflecting mirror. Since both front and rear surfaces are reflective, the measuring distance can be doubled. A permanent magnet makes it very effective for measuring the squareness and straightness of iron materials.

- Effective aperture of reflecting surface (both sides): 70 mm
- Distance between legs of mirror stand: 100 mm
- Permanent magnet: removable, provided with on/off knob
- Wooden case provided



Plane Mirror C

Both sides are perfectly parallel, permitting its use as a reference for non-reflective surface. Also useful for measuring extremely small angles where a smaller mirror is desirable.

- Outer diameter: 30 mm
- Thickness: 12 mm
- Parallelism: 2 seconds of arc
- Wooden case provided



8-sided Polygon Mirror

Precisely divides 360° into 8 equal parts to check for eccentricity and errors in goniometers and other angle gauges.

- Guaranteed accuracy: 1 second of arc for compensated values
- Outer diameter: 117 mm
- Diameter of center hole: 20 mm
- Thickness: 46 mm
- Wooden case provided



LED Illuminator AC-L1

LED illumination unit for retrofitting onto Autocollimator 6B/6D illumination unit.

- Power source: AA batteries x2, AC adaptor



Plane Mirror D

General-purpose plane mirror. Base and both sides of the stand serve as guides for measuring straightness and flatness. The mirror can also be removed from the stand and placed on the surface to be measured.

- Effective aperture of reflecting surface: 42 mm
- Distance between legs of mirror stand: 100 mm
- Wooden case provided

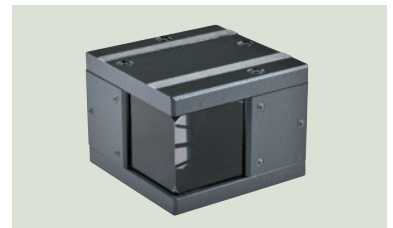

Pentaprism

Turns the optical axis of the autocollimator exactly 90° for use as an optical square to measure the squareness of two surfaces.

- Guaranteed accuracy (optical right angle): 2 seconds of arc
- Dimensions: 65 x 65 x 45 mm
- Metal frame and wooden case provided



12-sided Polygon Mirror

Accurately divides 360° into 12 equal parts to check for eccentricity and errors in goniometers and other angle gauges.

- Guaranteed accuracy: 1 second of arc for compensated values
- Outer diameter: 117 mm
- Diameter of center hole: 20 mm
- Thickness: 46 mm
- Wooden case provided

Typical Examples of Use

Check the angular accuracy of rotary tables

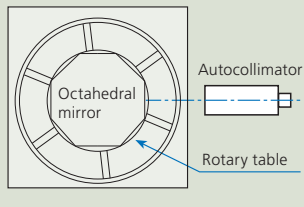

Measure the accuracy of rotary tables or dividing heads using polygon mirrors. The octahedral mirror measures in units of 45°, and the dodecahedral mirror in units of 30°.

Check the deflection of elastic or springy materials

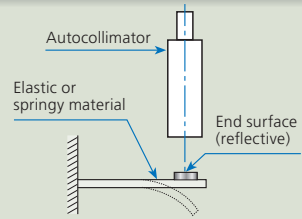

Affix the mirror to the specimen and read the angular deflection using the autocollimator. Small vibrations may also be detected in this manner.

Check the parallelism of end surfaces

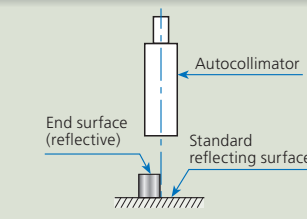

Compare the difference between the crosshair images reflected from the surface of the specimen and from a standard surface.

Check the angle of work pieces

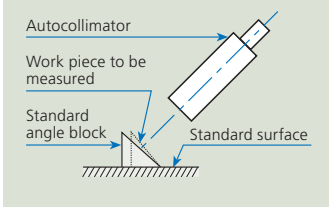

Measure the difference between the crosshair images reflected from the end surface of the work piece and from a standard angle block.

Check the squareness of rectangular pieces

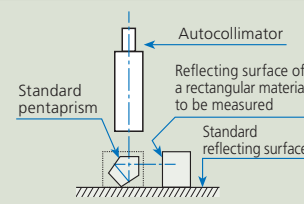

Compare the reading difference between the standard reflecting surface and the surface of the specimen using the Pentaprism.

Check for straightness of movement

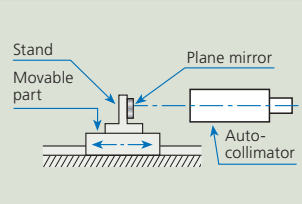

Attach a plane mirror, either directly or on a stand, to the moving part and read deviation from the reflection.

Check the squareness of surfaces

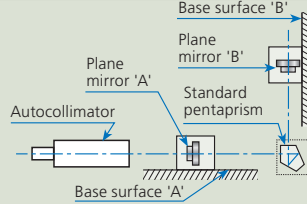

Compare the readings taken from plane mirror 'a' on surface 'A' to those from plane mirror 'b' on surface 'B' through the Pentaprism.

Specifications and equipment are subject to change without any notice or obligation on the part of the manufacturer. November 2019 ©2008-2019 NIKON CORPORATION

N.B. Export of the products* in this catalog is controlled under the Japanese Foreign Exchange and Foreign Trade Law. Appropriate export procedures shall be required in case of export from Japan.

*Products: Hardware and its technical information (including software)



WARNING

TO ENSURE CORRECT USAGE, READ THE CORRESPONDING MANUALS CAREFULLY BEFORE USING THE EQUIPMENT.



NIKON CORPORATION

Shinagawa Intercity Tower C, 2-15-3, Konan, Minato-ku, Tokyo 108-6290, Japan
phone: +81-3-6433-3701 fax: +81-3-6433-3784
<https://www.nikon.com/products/industrial-metrology/>

ISO 14001 Certified
for NIKON CORPORATION

ISO 9001 Certified
for NIKON CORPORATION
Industrial Metrology Business Unit

NIKON METROLOGY EUROPE NV

Geldenaaksebaan 329, 3001 Leuven, Belgium
phone: +32-16-74-01-00 fax: +32-16-74-01-03
E-mail: Sales.Europe.NM@nikon.com
<http://www.nikonmetrology.com/en-gb>

NIKON METROLOGY UK LTD.

UNITED KINGDOM phone: +44-1332-811-349 fax: +44-1332-639-881
E-mail: Sales.UK.NM@nikon.com

NIKON METROLOGY SARL

FRANCE phone: +33-1-60-86-09-76 fax: +33-1-60-86-57-35
E-mail: Sales.France.NM@nikon.com

NIKON METROLOGY GMBH

GERMANY phone: +49-6023-91733-0 fax: +49-6023-91733-229
E-mail: Sales.Germany.NM@nikon.com

NIKON INSTRUMENTS S.p.A.

ITALY phone: +39-055-300-96-01 fax: +39-055-30-09-93

NIKON METROLOGY, INC.

12701 Grand River Avenue, Brighton, MI 48116 U.S.A.
phone: +1-810-220-4360 fax: +1-810-220-4300
E-mail: Sales.NM-US@nikon.com
<http://www.nikonmetrology.com/en-us>

NIKON CANADA INC.

CANADA phone: +1-905-602-9676 fax: +1-905-602-9953

NIKON MEXICO- Metrology Showroom

MEXICO phone: +52 (442) 688 5067
E-mail: Sales.NM-MX@nikon.com

NIKON INSTRUMENTS (SHANGHAI) CO., LTD.

CHINA (Shanghai branch) phone: +86-21-6841-2050 fax: +86-21-6841-2060
(Beijing branch) phone: +86-10-5831-2028 fax: +86-10-5831-2026
(Guangzhou branch) phone: +86-20-3882-0551 fax: +86-20-3882-0580

NIKON INSTRUMENTS KOREA CO., LTD.

KOREA phone: +82-2-2186-8400 fax: +82-2-555-4415

NIKON SINGAPORE PTE LTD.

SINGAPORE phone: +65-6559-3651 fax: +65-6559-3668
E-mail: NSG.Industrial-sales@nikon.com

NIKON MALAYSIA SDN BHD

MALAYSIA phone: +60-3-7809-3688 fax: +60-3-7809-3633

PT. NIKON INDONESIA

INDONESIA phone: +62-267-864-3949 fax: +62-267-864-3950
E-mail: PTN.Instruments@nikon.com

NIKON SALES (THAILAND) CO., LTD.

THAILAND phone: +66-2633-5100 fax: 66-2633-5191

NIKON INDIA PRIVATE LIMITED

INDIA phone: +91-124-4688500 fax: +91-124-4688527