



# ECLIPSE LV100N POL *Ci*-POL

Polarizing Microscopes



# The highest level of optical quality,

- The low-power-consumption 50W light source is brighter than a 100W lamp, and reduces heat-induced focus drift and energy consumption.
- High-precision centerable nosepiece and stage with smooth, accurate movement. (LV100N POL only)
- 30mm long focus stroke accepts tall samples.



**Reversed centering quintuple nosepiece**

Up to five objectives can be mounted and all objective positions are centerable. The DIN-compliant compensator slot accepts various compensators for qualitative or quantitative measurements.



**High-precision rotating stage**

The LV100N POL stage is large, pre-adjusted, and click-stops in 45° increments. The smooth stage movement allows stable and easy rotation, providing high operability and high-quality polarized images. The underneath support for the stage table is close to the optical axis. Together with the steel cross roller guides, this provides outstanding stability and durability during regular use.

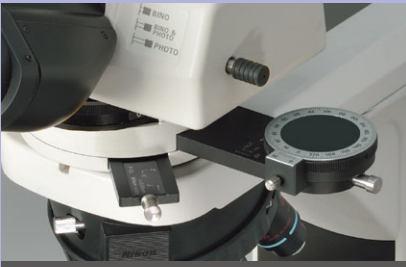

**Intermediate tube**

The intermediate tube incorporates a Bertrand lens as standard, enabling both the observation and capture of conoscopic and orthoscopic images. The Bertrand lens is focusable and centerable. The high precision slider-type analyzer can be rotated a full 360° with a precision vernier scale. A P-LC tint plate slider with full and quarter wave plates and an empty space is available.

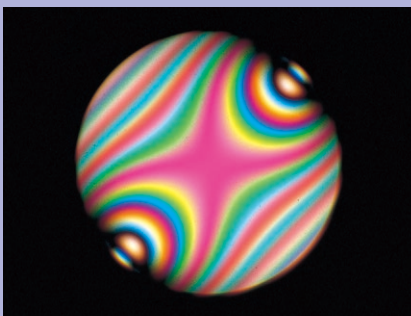

Conoscopic image of mica / CFI Achromat P 40X



**ECLIPSE Ci-POL**  
(Diascopic illumination)

**ECLIPSE Ci-POL**  
(Diascopic/Episcopic illumination)

## Objectives for polarizing observation

### CFI Achromat P objective series (for diascopic illumination)

The unique Nikon CFI60 objectives successfully deliver longer standard working distances and high numerical apertures, offering superb image flatness, contrast and cost performance.



### CFI TU Plan Fluor EPI P objective series (for diascopic/episcopic illumination)

The CFI TU Plan Fluor EPI P series of CFI60-2 objectives produce pin-sharp aberration-free images regardless of magnification.



Nikon CFI optics employ an eco-glass that is manufactured with no harmful substances such as lead and arsenic.



# operability and stability for polarizing microscopy

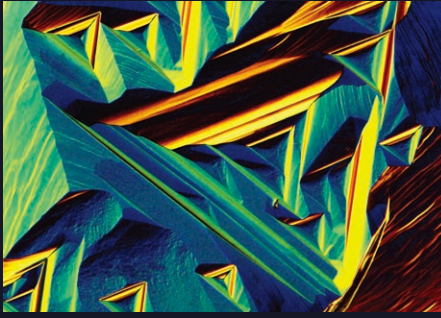

1

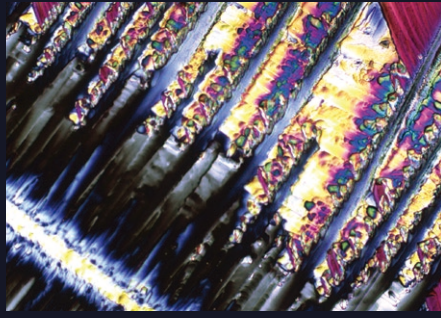

2

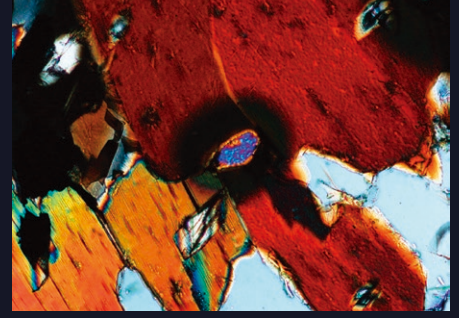

3



**ECLIPSE LV100N POL**  
(Diascopic illumination)



**ECLIPSE LV100N POL**  
(Diascopic/Episcopic illumination)

## ECLIPSE LV100N POL Diascopic illumination type

### Outstanding optical performance, perfect for a wide variety of imaging applications and polarizing techniques

Nikon has developed a high-intensity 50W halogen light source (with dedicated lamphouse) that provides greater brightness than a conventional 100W halogen light source. Brightness is increased by approximately 20 to 40% with objective magnifications of 50X and higher. This light source consumes less electrical power and generates very little heat, greatly reducing focus drift resulting from light source heat.

- Microscope body is designed to realize high robustness.
- Unique stage mount design ensures exceptional stability.
- Nosepiece comes with a DIN standard compensator slot.
- All five objective positions on the nosepiece are centerable.
- Uses CFI60 optics, realizing both high NA and longer standard working distances.
- A clamp-type upper limit focusing mechanism makes for easy, safe sample exchange, protecting both sample and optics from collision damage.

#### Why is 50W brighter than 100W?

Brightness is not determined by wattage. Nikon's unique light source design achieves greater brightness by optimizing the lamp filament size and improving pupil illumination fulfillment. The latter has been achieved by optically expanding the size of the light source with a mirror in the lamphouse. This has resulted in a 50W light source that is brighter than a 100W lamp—about 40% brighter with diascope illumination\*.

\*With 100X objectives.

#### Uniform brightness with diascope illumination

Nikon's unique fly-eye lens has been employed in diascope illumination optics. This enables high quality imaging with no variations in luminescence throughout the view field.

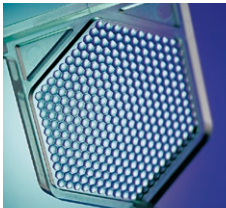

Concept of Fly-eye Lens



Fly-eye lens



Ordinary lens

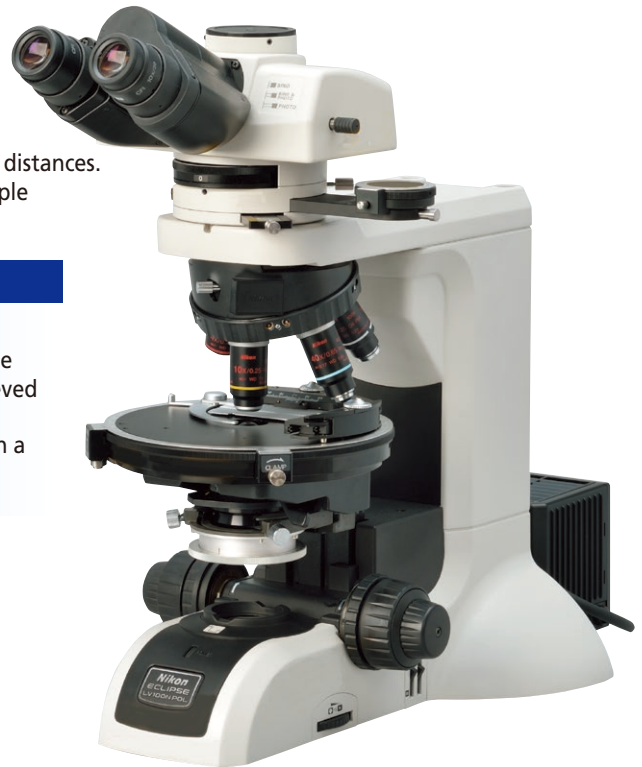

## ECLIPSE Ci-POL Diascopic illumination type

### A compact polarizing microscope that balances optical performance and ease of use

- Slim and compact, an excessively large working area is not necessary.
- Nosepiece uses the same DIN standard compensator slot design as LV100N POL.
- All five objective positions on the nosepiece are centerable.
- Uses CFI60 optics, realizing both high NA and long standard working distances.
- A clamp-type upper limit focusing mechanism makes for easy, safe sample exchange, protecting both sample and optics from collision damage.
- Excellent cost effective and precision manufacturing is balanced with superb basic performance for a polarizing microscope.
- Built-in capture button allows easy imaging with the DS-Fi3 and DS-Ri2 cameras (Please see page 6).





# ECLIPSE LV100N POL Diascopic/Episcopic illumination type

## ECLIPSE Ci-POL Diascopic/Episcopic illumination type

### Accomplishes advanced polarizing microscopy under both diascopic and episcopic illumination

Both diascopic and episcopic polarizing observations are possible by mounting the LV-UEPI-N Universal Epi-illuminator\*. Switching the illumination technique is a simple operation. The epi-illuminator uses a Nikon 12V50W light source that provides brighter illumination than a 100W lamp. The noise-terminator mechanism provides sharp images with high S/N ratios by eliminating stray light. With the optional universal-type nosepiece and DIC accessories including objectives, episcopic differential interference contrast (DIC) microscopy is also possible.

\* When used with the Ci-POL, LV-UEPI-N requires an external power supply.



**ECLIPSE LV100N POL**  
(Diascopic/Episcopic illumination type)



**ECLIPSE Ci-POL**  
(Diascopic/Episcopic illumination type)

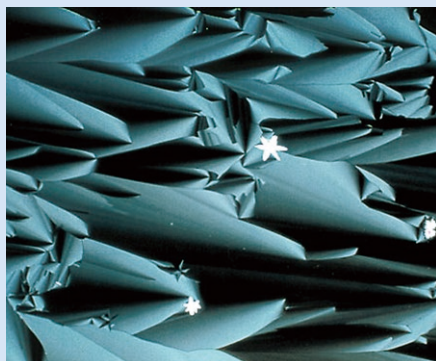

1

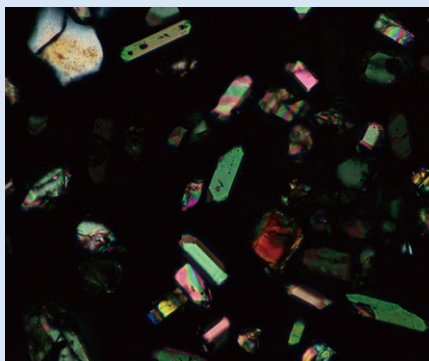

2

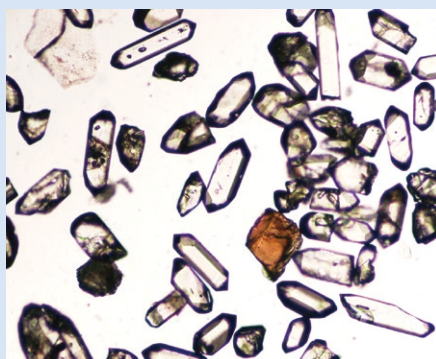
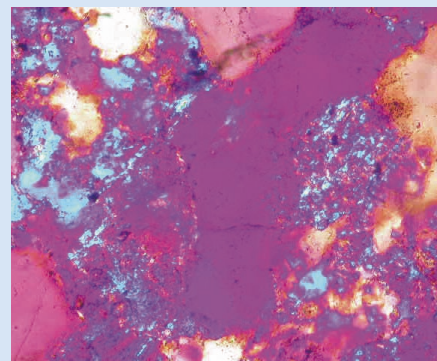

3

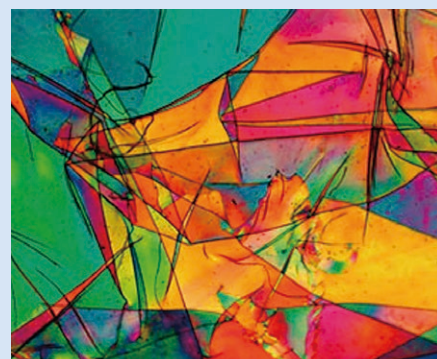

## Optional Accessories for Polarizing Observations

### Attachable mechanical stage

To improve microscopy efficiency, an attachable mechanical stage can be mounted on the rotating stage to rigidly hold and move the sample.

Cross travel: 35 x 25 mm

Minimum increment: 0.1mm on the vernier

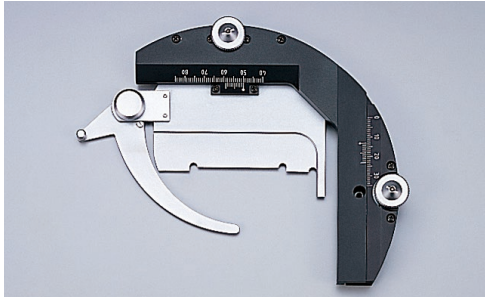

### Berek compensator

Inserted into the nosepiece slot, this compensator permits retardation measurements from 0 to 1800 nm.

Manufactured by Nichika Corporation.

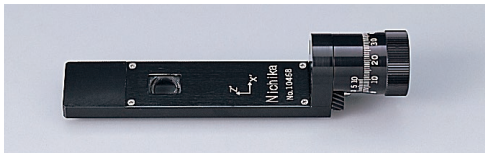

### Senarmont compensator

Inserted into the intermediate tube. In addition to the standard use  $1/4 \lambda$  plate and a 546 nm ( $1 \lambda$ ) tint plate (1st order red plate), a Senarmont compensator is also available as an option, for retardation measurements from 0 to  $1 \lambda$ .

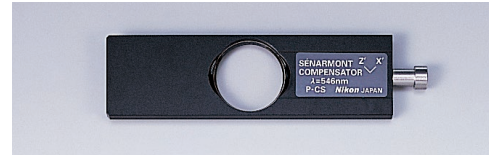

### Quartz wedge compensator

Inserted into the intermediate tube, this compensator permits retardation measurements from 1 to 6  $\lambda$  orders.

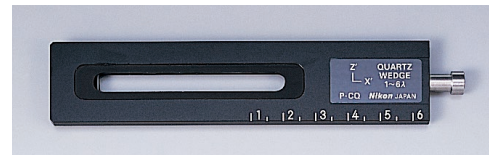

### IF 546/12 retardation filter

High-precision interference filter with a 546 nm central wavelength and 12 nm FWHM (full-width at half maximum). Used to increase the precision of retardation measurements.

## Digital Camera for Microscopes

When the DS-Fi3 and DS-Ri2 cameras are connected directly to a PC, the NIS-Elements software allows the acquisition, processing, measurement and analysis of images, as well as data management and report creation.

### C-mount camera

#### DS-Fi3 Microscope Camera

Equipped with a 5.9-megapixel CMOS sensor, the DS-Fi3 enables fast 15 fps acquisition of high definition images of up to 2880 x 2048 pixels with superior color reproduction for vivid polarized images. It also provides smooth live image movement and high sensitivity imaging of weak-light polarization samples.



### F-mount camera

#### DS-Ri2 Microscope Camera

Equipped with a 16.25-megapixel FX-format CMOS sensor for digital SLR cameras, the DS-Ri2 provides high definition images of up to 4908 x 3264 pixels, as well as high sensitivity, accurate color reproduction of interference colors and fast frame rates of up to 45 fps (1636 x 1088 pixels).



# System Diagram

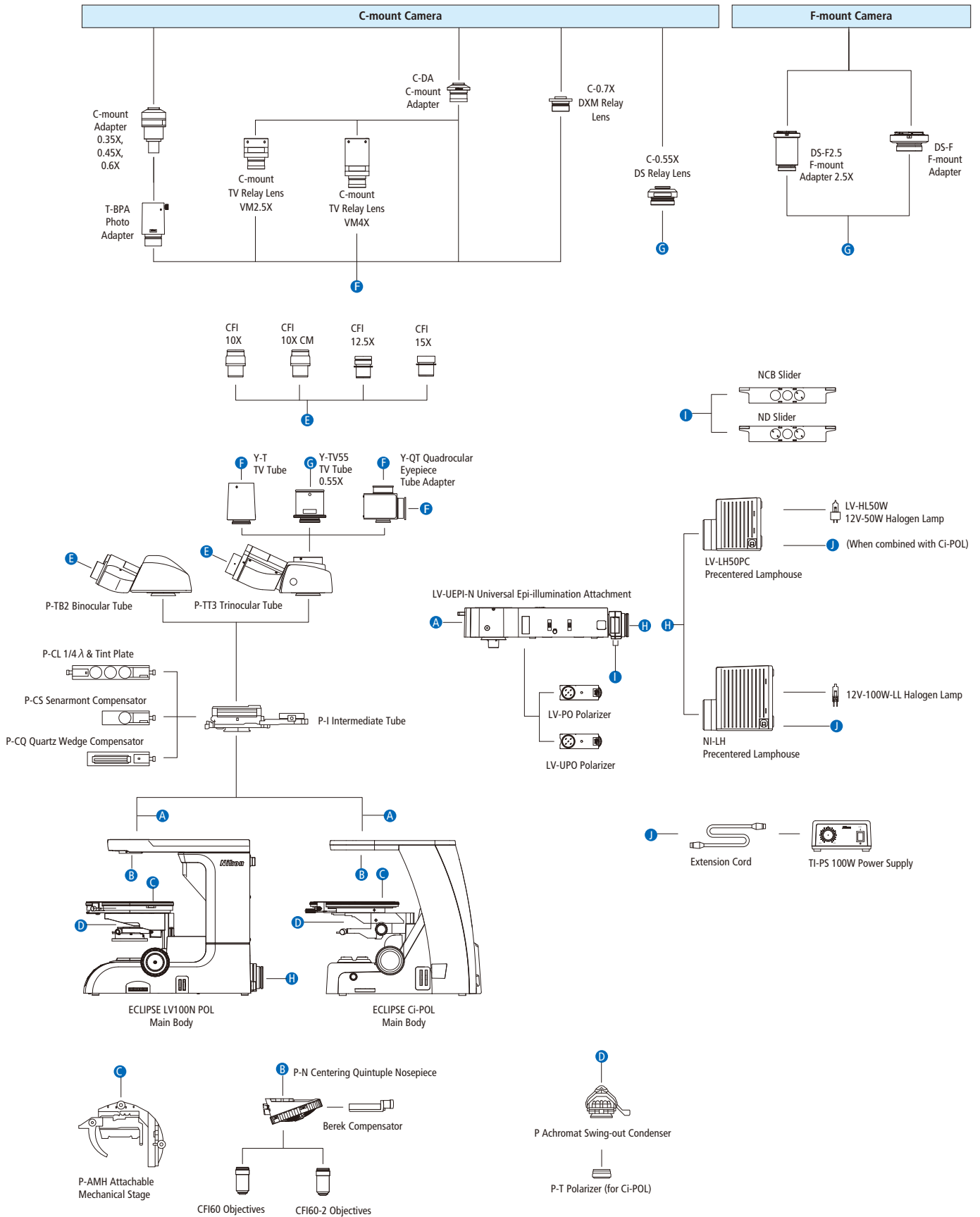



## Specifications

		ECLIPSE LV100N POL	ECLIPSE Ci-POL
Main body	Optical system	CFI60 infinity	
	Illumination	12V-50W halogen lamp; 12V-50W DC transformer built-in; Diascopic/episcopic illumination changeover switch; Fly-eye lens; NCB11, ND8 filters built-in; 12V-100W type optional	6V-30W halogen lamp; 6V-30W transformer built-in; ND8, ND4 filters built-in
	Focusing	Coaxial coarse/fine focus knob; Focus stroke: 30mm; Coarse: 14mm per rotation; Fine: 0.1mm; Minimum reading: in 1µm increments	Coaxial coarse/fine focus knob; Focus stroke: 30mm; Coarse: 9.33mm per rotation; Fine: 0.1mm; Minimum reading: in 1µm increments
Eyepieces (F.O.V., mm)		CFI 10X (22), CFI 10X CM (22), CFI 12.5X (16), CFI 15X (14.5)	
Tubes		P-TT3 Trinocular Tube for polarizing microscopy; P-TB2 Binocular Tube for polarizing microscopy	
Intermediate tube		Built-in focusable Bertrand lens removable from optical path; Conoscopic/Orthoscopic observations switchable; Analyzer built-in; Accessory plate/compensator slot	
Analyzer		360° rotary dial; Minimum reading angle 0.1°	
Nosepiece		Centering quintuple nosepiece (detachable); DIN slot	
Stages		Top-grade dedicated circular graduated stage Rotatable 360° horizontally; can be fixed at a specific position; Graduated 360° (in 1° increments); Click stops each 45°; Attachable mechanical stage: 35 x 25 mm travel; vernier 0.1mm	Ball bearing rotary stage; Rotatable 360° horizontally; can be fixed at a specific position; Graduated 360° (in 1° increments); Rotation clamp equipped; Attachable mechanical stage: 35 x 25 mm travel; vernier 0.1mm
Condenser		Dedicated strain-free swing-out type; P Achromat NA 0.9	
Polarizers		Fixed to the bottom of the condenser holder; with scale markings	No scale markings
Objectives (Polarizing sets)		CFI Achromat P 4X, P 10X, LWD P 20X, P 40X, P 100X Oil CFI TU Plan Fluor EPI P 5X, P 10X, P 20X, P 50X, P 100X	
Episcopic illuminator		LV-UEPI-N Universal Epi-illuminator (The LV100N POL accommodates a 12V-50W illuminator transformer)	LV-UEPI-N Universal Epi-illuminator (The Ci-POL requires an external power supply)
Compensators		P-CL Standard 1/4 λ & tint plate, quartz wedge or Senarmont compensator can be inserted into intermediate tube slot	
Power consumption		1.2A/75W	0.8A/38W
Weight		Approx. 17kg (standard trinocular set)	Approx. 14kg (standard binocular set)

## Dimensional Diagram

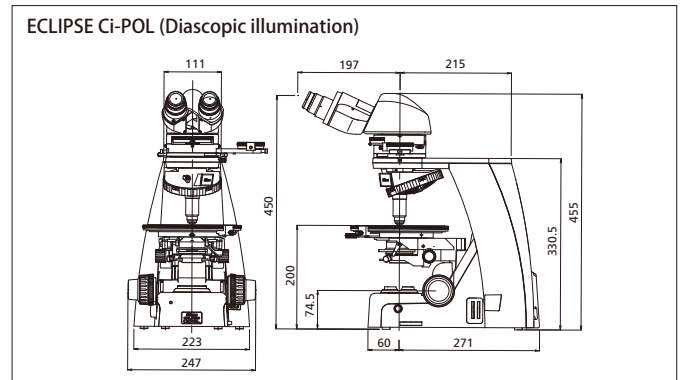
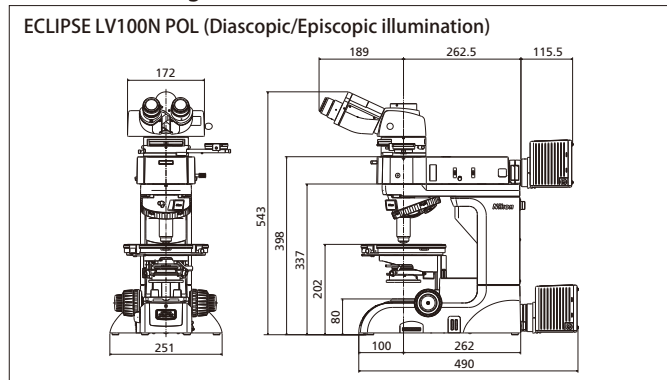

Unit: mm

Images courtesy of:  
Dr. Kazuhiro Suzuki and Dr. Takenori Kato, Center for Chronological Research, Nagoya University (● on page 3, ● on page 5)  
Ron Sturm, Construction Technology Laboratories, Inc., U.S.A. (● on page 5)  
Mike Davidson, Florida State University, U.S.A. (● on page 3, ● on page 5)

Company names and product names appearing in this brochure are their registered trademarks or trademarks.  
N.B. Export of the products\* in this brochure is controlled under the Japanese Foreign Exchange and Foreign Trade Law.  
Appropriate export procedure shall be required in case of export from Japan.  
\*Products: Hardware and its technical information (including software)



**WARNING**

TO ENSURE CORRECT USAGE, READ THE CORRESPONDING MANUALS CAREFULLY BEFORE USING YOUR EQUIPMENT.

Specifications and equipment are subject to change without any notice or obligation on the part of the manufacturer. December 2018 ©2005-2018 NIKON CORPORATION



### NIKON CORPORATION

Shinagawa Intercity Tower C, 2-15-3, Konan, Minato-ku, Tokyo 108-6290, Japan  
Healthcare Business Unit, phone: +81-3-6433-3705 fax: +81-3-6433-3785  
<https://www.healthcare.nikon.com/>  
Industrial Metrology Business Unit, phone: +81-3-6433-3701 fax: +81-3-6433-3784  
<https://www.nikon.com/products/industrial-metrology/>

ISO 14001 Certified  
for NIKON CORPORATION

ISO 9001 Certified  
for NIKON CORPORATION  
Industrial Metrology Business Unit

### NIKON INSTRUMENTS INC.

1300 Walt Whitman Road, Melville, N.Y. 11747-3064, U.S.A.  
phone: +1-631-547-8500; +1-800-52-NIKON (within the U.S.A. only)  
fax: +1-631-547-0306

<https://www.microscope.healthcare.nikon.com/>

### NIKON METROLOGY, INC.

12701 Grand River Avenue, Brighton, MI 48116 U.S.A.  
phone: +1-810-220-4360 fax: +1-810-220-4300

E-mail: [Sales.US-NM@nikon.com](mailto:Sales.US-NM@nikon.com)

<http://www.nikonmetrology.com/en-us>

### NIKON INSTRUMENTS EUROPE B.V.

Tripolis 100, Burgerweeshuispad 101, 1076 ER Amsterdam, The Netherlands

phone: +31-20-7099-000 fax: +31-20-7099-298

[https://www.microscope.healthcare.nikon.com/en\\_EU/](https://www.microscope.healthcare.nikon.com/en_EU/)

### NIKON METROLOGY EUROPE NV

Geldenaaksebaan 329, 3001 Leuven, Belgium

phone: +32-16-74-01-00 fax: +32-16-74-01-03

E-mail: [Sales.Europe.NM@nikon.com](mailto:Sales.Europe.NM@nikon.com)

<http://www.nikonmetrology.com/en-gb>

### NIKON INSTRUMENTS (SHANGHAI) CO., LTD.

CHINA phone: +86-21-6841-2050 fax: +86-21-6841-2060

(Beijing branch) phone: +86-10-5831-2028 fax: +86-10-5831-2026

(Guangzhou branch) phone: +86-20-3882-0550 fax: +86-20-3882-0580

### NIKON INSTRUMENTS KOREA CO., LTD.

KOREA phone: +82-2-2186-8400 fax: +82-2-555-4415

### NIKON SINGAPORE PTE LTD

SINGAPORE phone: +65-6559-3651 fax: +65-6559-3668

### NIKON MALAYSIA SDN BHD

MALAYSIA phone: +60-3-7809-3688 fax: +60-3-7809-3633

### PT. NIKON INDONESIA

INDONESIA phone: +62-267-8643949 fax: +62-267-8643950

### NIKON SALES (THAILAND) CO., LTD.

THAILAND phone: +66-2633-5100 fax: 66-2633-5191

### NIKON INDIA PRIVATE LIMITED

INDIA phone: +91-124-4688500 fax: +91-124-4688527

### NIKON MEXICO- Metrology Showroom

MEXICO phone: +52-442-688-5067

E-mail: [Sales.NM-MX@nikon.com](mailto:Sales.NM-MX@nikon.com)

### NIKON CANADA INC.

CANADA phone: +1-905-602-9676 fax: +1-905-602-9953

### NIKON INSTRUMENTS S.p.A.

ITALY phone: +39-55-300-96-01 fax: +39-55-300-09-93

### NIKON GMBH SWITZERLAND

SWITZERLAND phone: +41-43-277-28-67 fax: +41-43-277-28-61

### NIKON CEE GMBH

AUSTRIA phone: +43-1-972-6111 fax: +43-1-972-611-140

### NIKON UK LTD.

UNITED KINGDOM: phone: +44-208-247-1717 fax: +44-208-541-4584

### NIKON METROLOGY UK LTD.

UNITED KINGDOM: phone: +44-1332-811-349 fax: +44-1332-639-881

E-mail: [Sales.UK.NM@nikon.com](mailto:Sales.UK.NM@nikon.com)

### NIKON FRANCE S.A.S.

FRANCE phone: +33-1-4516-45-16 fax: +33-1-4516-45-55

### NIKON METROLOGY SARL

FRANCE phone: +33-1-60-86-09-76 fax: +33-1-60-86-57-35

E-mail: [Sales.France.NM@nikon.com](mailto:Sales.France.NM@nikon.com)

### NIKON GMBH

GERMANY phone: +49-211-941-42-20 fax: +49-211-941-43-22

### NIKON METROLOGY GMBH

GERMANY phone: +49-6023-91733-0 fax: +49-6023-91733-229

E-mail: [Sales.Germany.NM@nikon.com](mailto:Sales.Germany.NM@nikon.com)